

Firma Firma CNC Steuerung Jerichostraße 28 46399 Bocholt	Titel Patchkabel	Sachnummer		
		Dokumentenart		
Abteilung	Erstellt durch	Ausgabedatum		
	Genehmigt von	Maßstab		Blatt 1

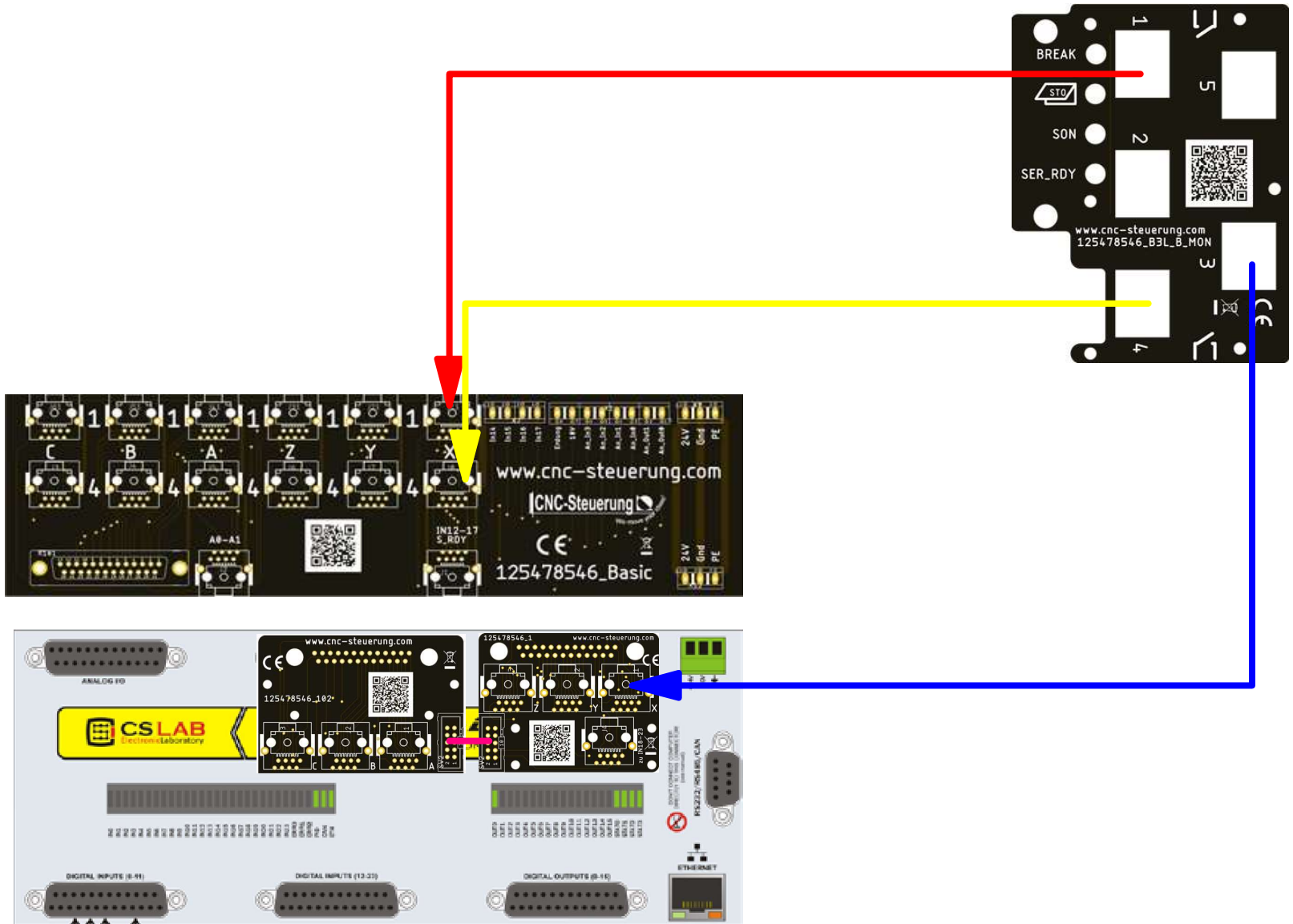

Firma Firma CNC Steuerung Jerichostraße 28 46399 Bocholt	Titel X Achse	Sachnummer		
	Erstellt durch	Ausgabedatum		
Abteilung	Genehmigt von	Maßstab		Blatt 2

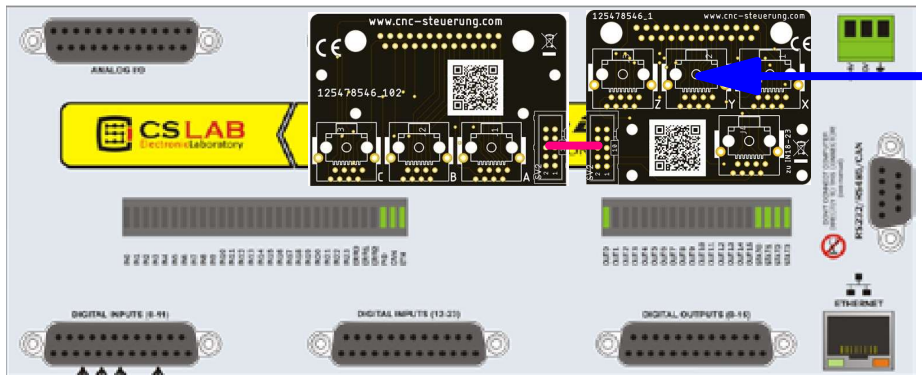
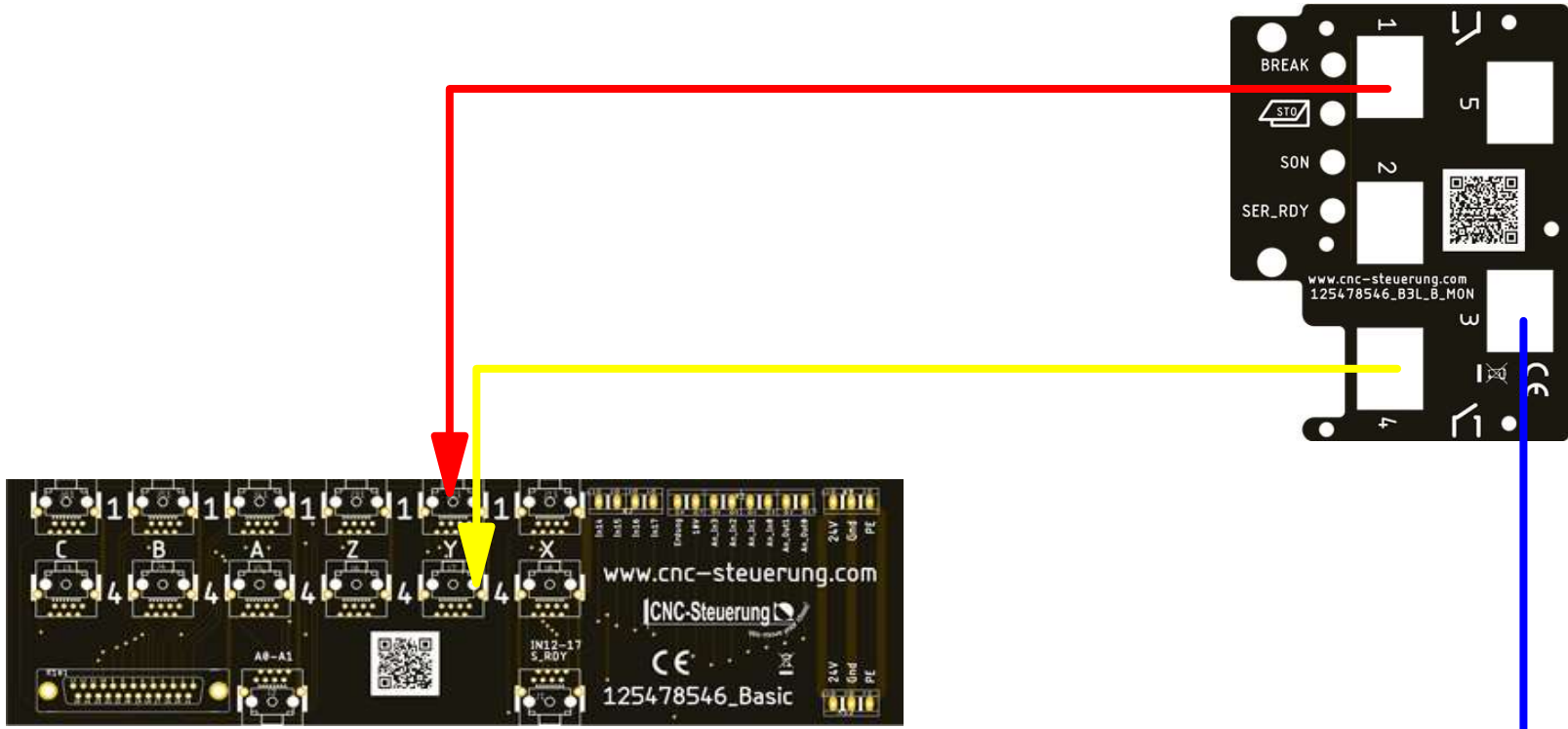

Firma Firma CNC Steuerung Jerichostraße 28 46399 Bocholt	Titel Y Achse	Sachnummer		
	Erstellt durch	Ausgabedatum		
Abteilung	Genehmigt von	Maßstab		Blatt 3

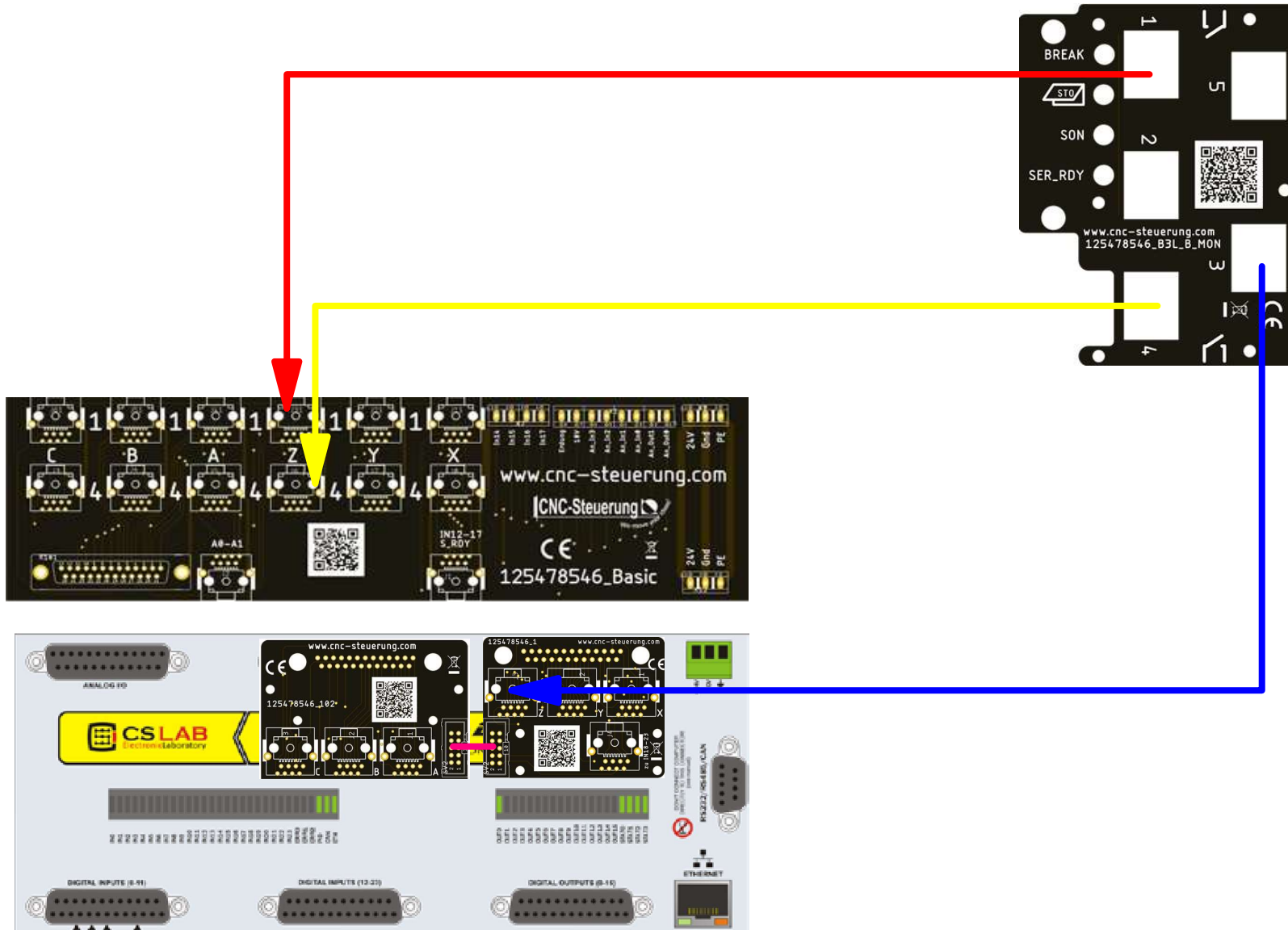

Firma Firma CNC Steuerung Jerichostraße 28 46399 Bocholt	Titel Z Achse	Sachnummer		
	Erstellt durch	Ausgabedatum		
Abteilung	Genehmigt von	Maßstab		Blatt 4

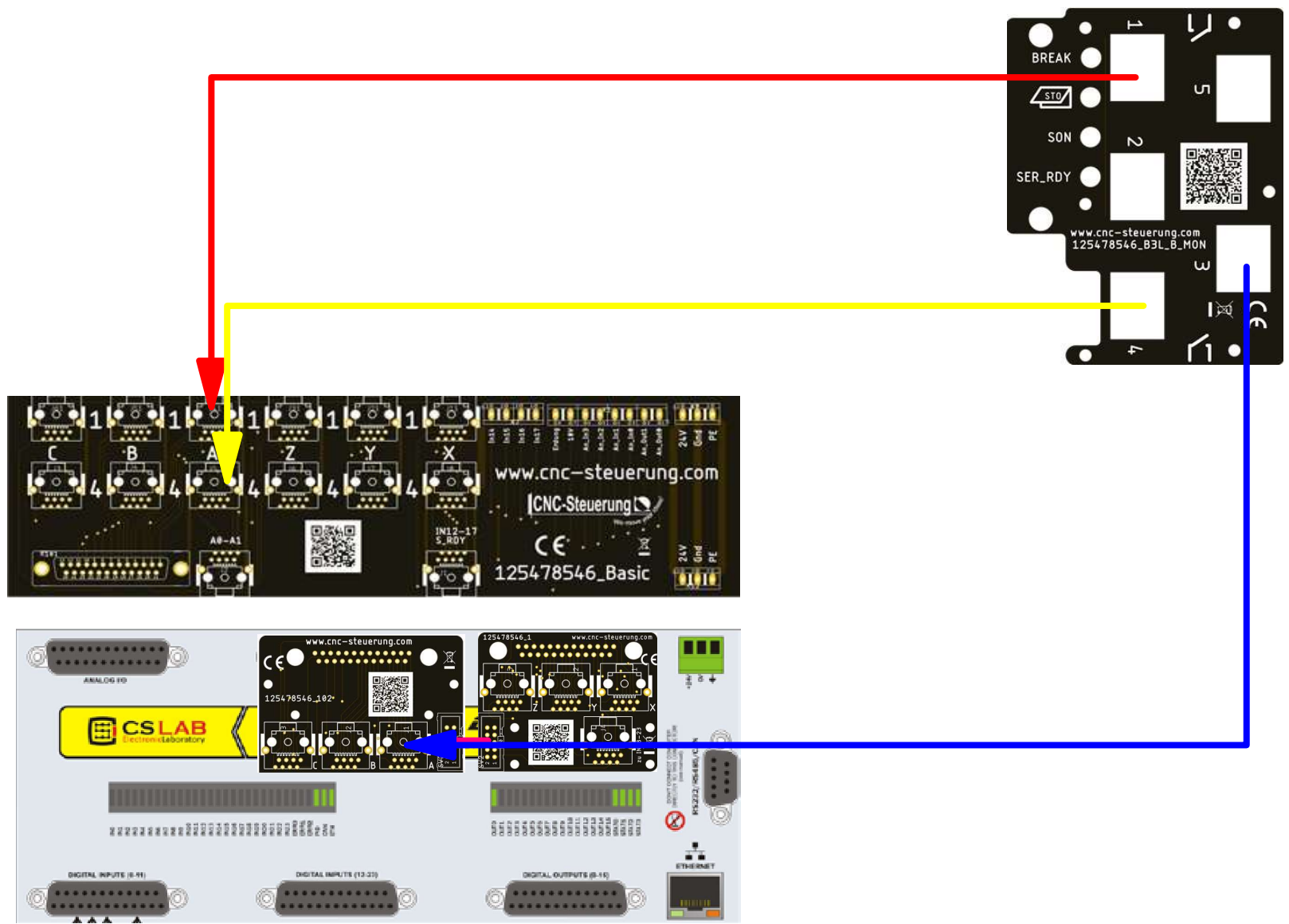

Firma Firma CNC Steuerung Jerichostraße 28 46399 Bocholt	Titel A Achse	Sachnummer		
	Erstellt durch	Ausgabedatum		
Abteilung	Genehmigt von	Maßstab		Blatt 5

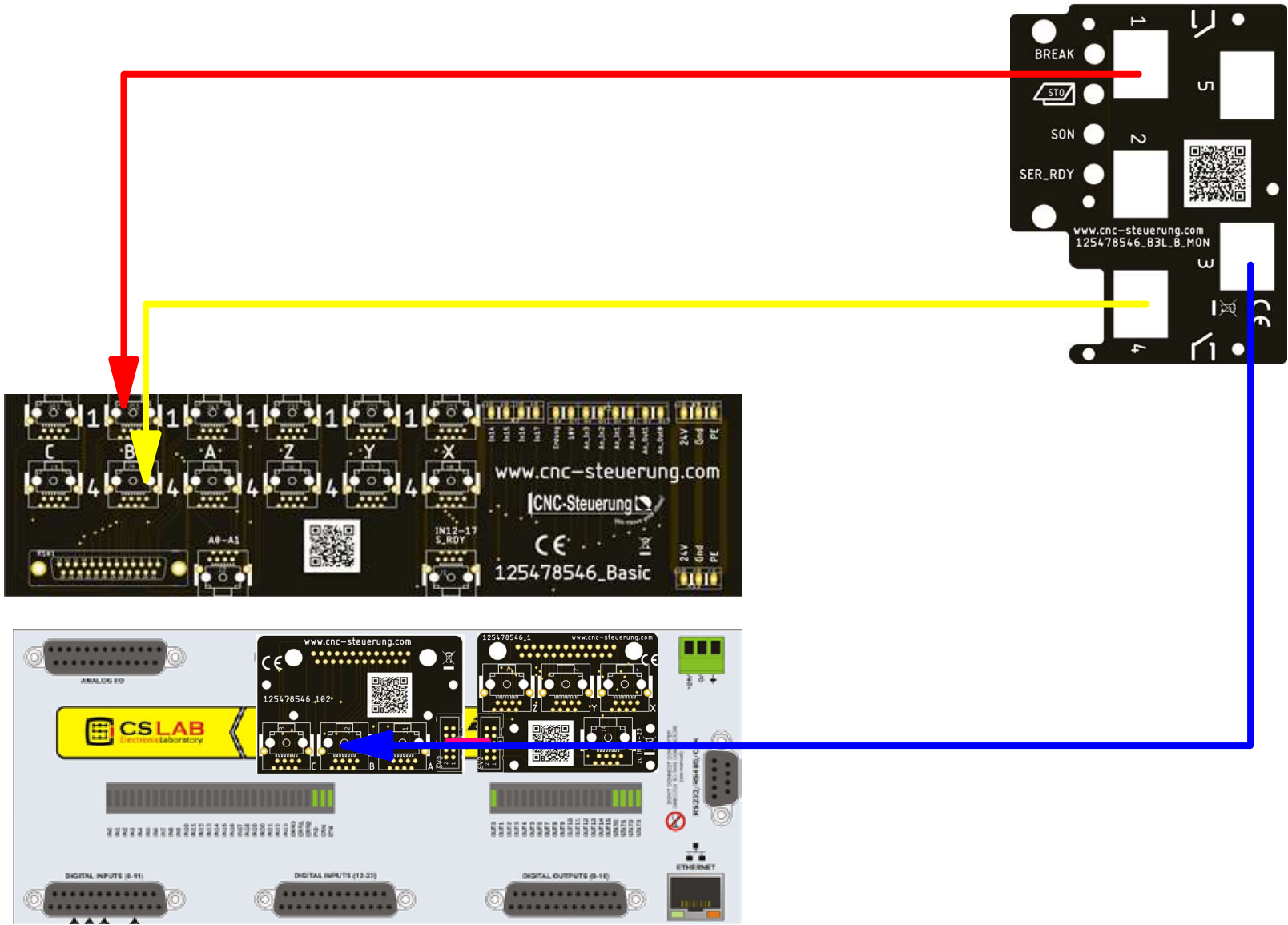

Firma Firma CNC Steuerung Jerichostraße 28 46399 Bocholt	Titel B Achse	Sachnummer		
	Erstellt durch	Ausgabedatum		
Abteilung	Genehmigt von	Maßstab		Blatt 6

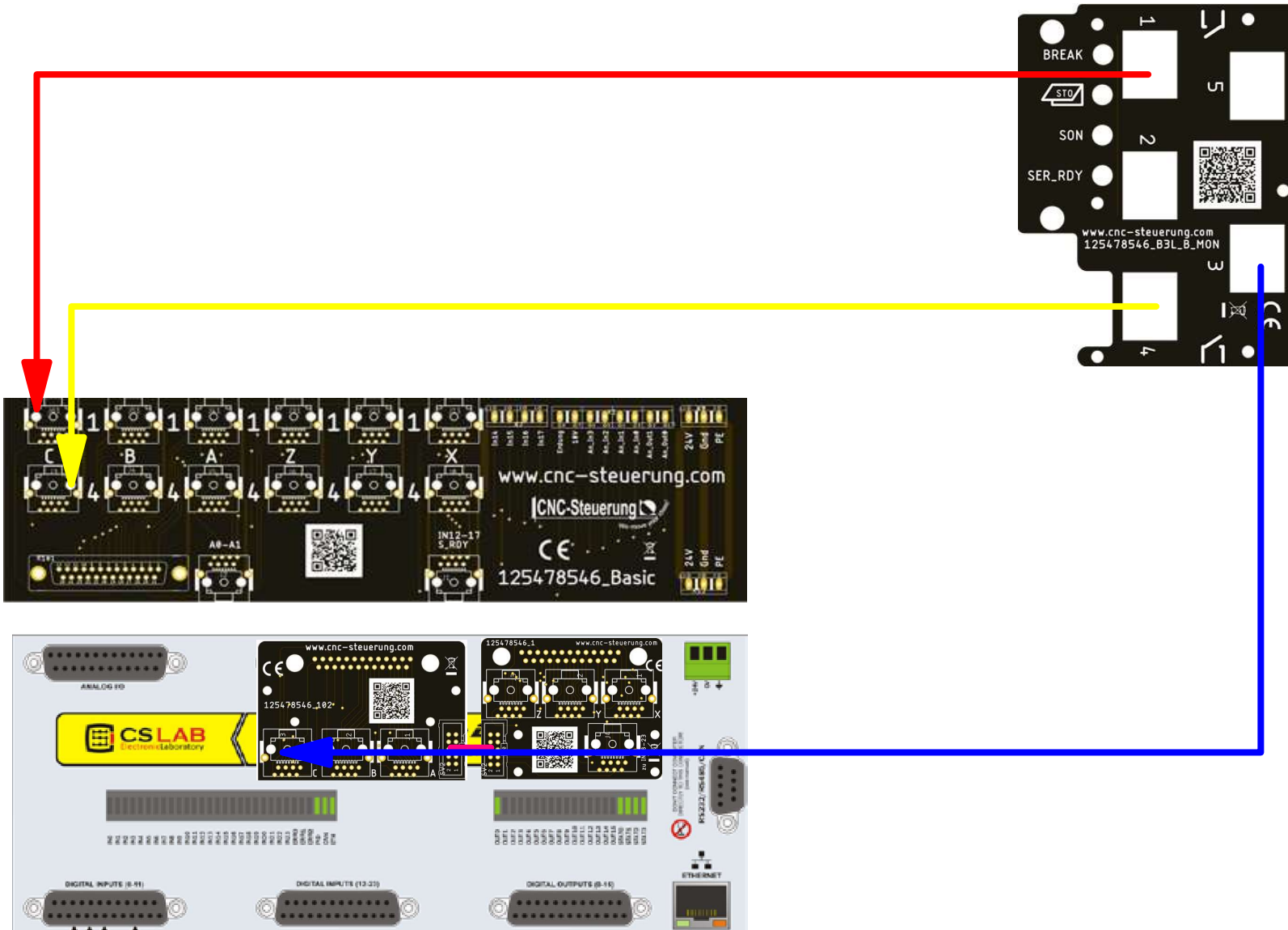

Firma Firma CNC Steuerung Jerichostraße 28 46399 Bocholt	Titel C Achse	Sachnummer		
	Erstellt durch	Ausgabedatum		
Abteilung	Genehmigt von	Maßstab		Blatt 7

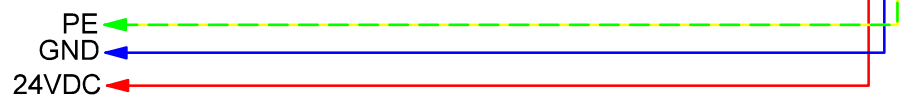
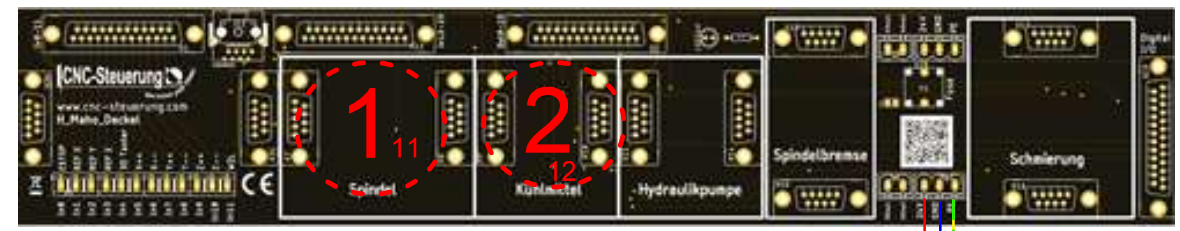
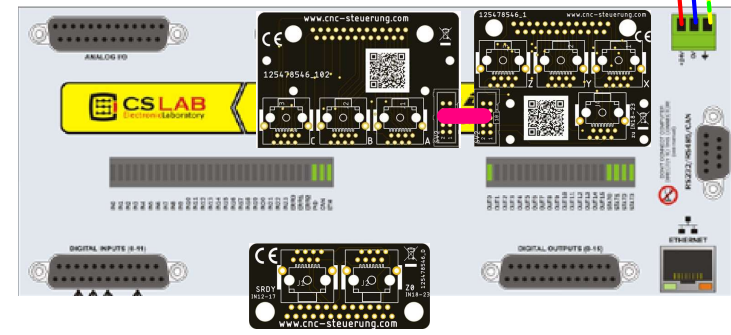
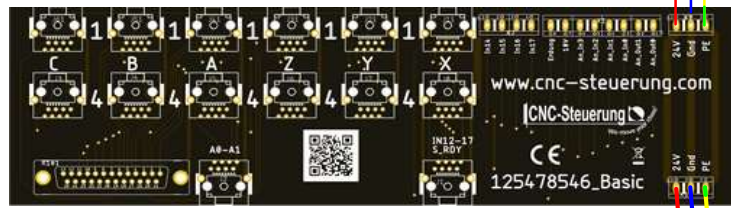
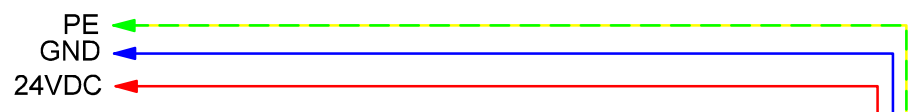

Firma Firma CNC Steuerung Jerichostraße 28 46399 Bocholt	Titel Stromversorgung	Sachnummer		
		Dokumentenart		
Abteilung	Erstellt durch	Ausgabedatum		
	Genehmigt von	Maßstab		Blatt 8

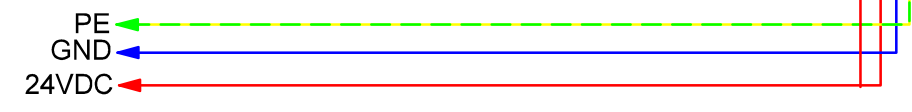
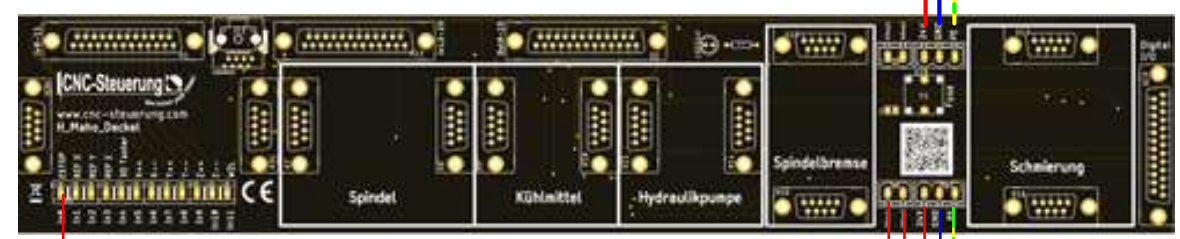
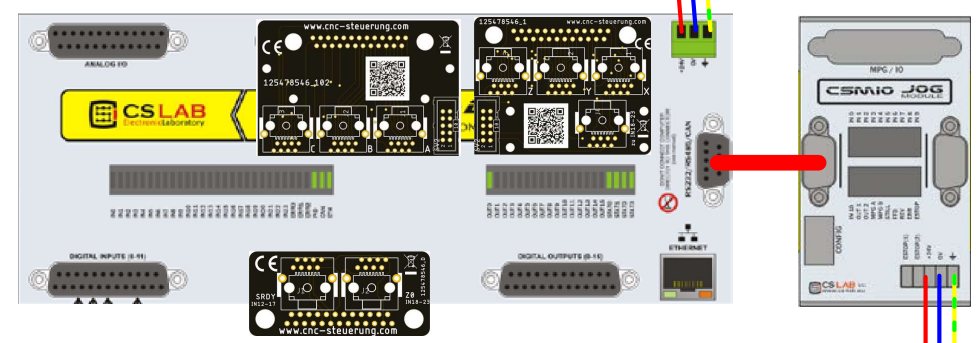
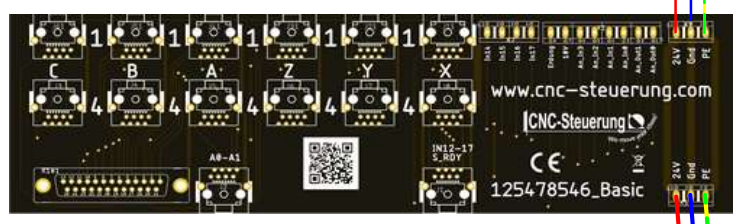
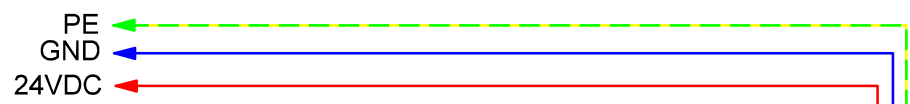

Firma
Firma CNC Steuerung
 Jerichostraße 28
 46399 Bocholt

Titel Stromversorgung MPG	Sachnummer		
	Dokumentenart		
Erstellt durch	Ausgabedatum		
Abteilung	Genehmigt von	Maßstab	Blatt 9

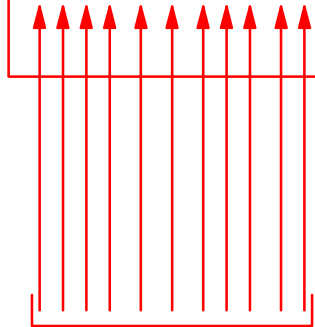
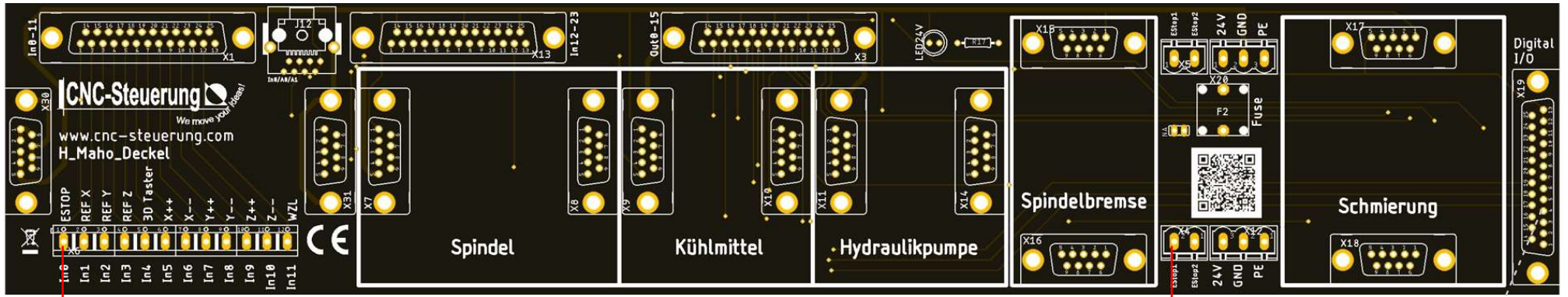

Digital IN

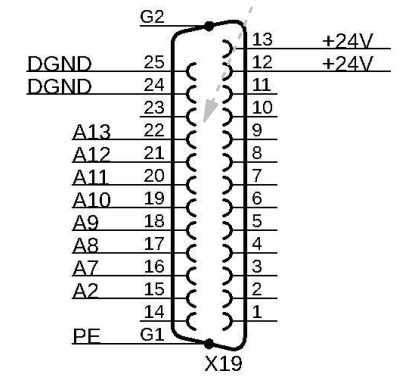

Firma Firma CNC Steuerung Jerichostraße 28 46399 Bocholt	Titel Ein/Ausgänge	Sachnummer	
		Dokumentenart	
Abteilung	Erstellt durch	Ausgabedatum	
	Genehmigt von	Maßstab	Blatt 10